

Surprise Tote

Project Description:

This Tote is a great fast and easy gift to make for anyone who travels a lot. The tote stores in the pocket sewn on the front of the tote. I normally make it out of Nylon Oxford Cloth which is strong, waterproof and light weight. Carry in your handbag or luggage as an extra bag for travel.

Supplies:

2/3 yards fabric (at least 47" wide) Nylon Oxford, Pack Cloth, or Cordura.
One Yard 1" Polypropolyene Webbing.

Directions:

 Use 1/2 inch seams throughout.

1) CUT TWO PIECES OF FABRIC 21" X 19" FOR FRONT AND BACK OF BAG. CUT ONE PIECE OF FABRIC 9" X 18" FOR POCKET. (If you are going to applique or embroider the pocket, you may want to draw out the size of the piece and do your design prior to cutting the piece to size.)
CUT TWO STRIPS OF 1 INCH WEBBING, 16 INCHES LONG.

2. OPTIONAL - APPLIQUE OR EMBROIDER ON POCKET PIECE. Mark fold line at center of 18" side of pocket. Fold in half and determine your design placement. (Remember if you want your design to be seen both when bag is open or folded away you must do the design twice. Embroider your design as shown in figure 1 as the letter A.

3) POCKET - Fold pocket piece RIGHT SIDES together and stitch along the two sides. Then turn right side out and press with cool iron. Mark center of open edge. See figures 2A and 2B.

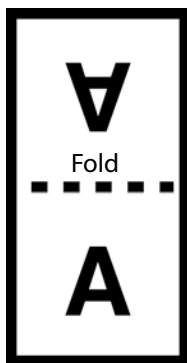

Figure 1(Pocket)

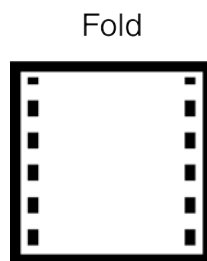
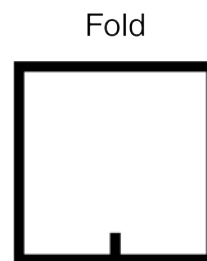
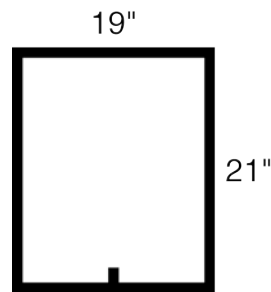

Fig 2A



Center
Fig 2B

4) BAG FRONT - On right side of 19 inch lower edge mark center. Place center of lower edge of pocket at center mark of the lower edge of bag. Top stitch 1/4 inch along both side edges of pocket, leaving top and bottom edges open. See figures 3 and 4.



Center
Figure 3

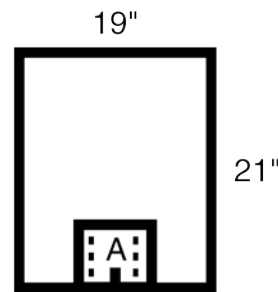

Center
Figure 4

5) BAG FRONT AND BACK - On right side of front and back pieces, mark a line 1/2" from top and 1 1/2 inches from the top with a removable marker. On 1 1/2 inch line place markings six inches from all sides (for placement of straps). With right sides together, stitch the side and lower seams. Turn right side out. See Figures 5A and 5B.

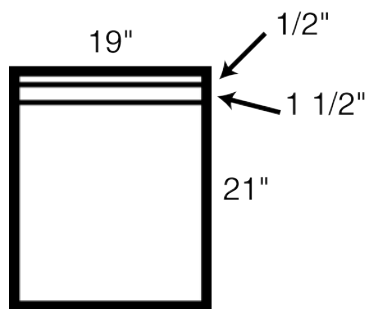

Figure 5A

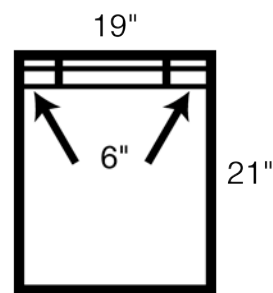

Figure 5B

6) TOP EDGE OF BAG - Fold top edge into 1 1/2 inch mark and top stitch 1/4 inch from edge. Fold 1/2 inch seam under and stitch down. See Figure 6A

7) WEBBING - Place straps on inside on markings and square stitch down. See Figure 6B.

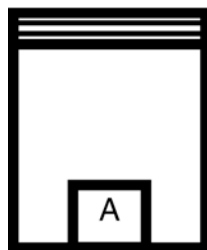

Figure 6A



Figure 6B

To Store Bag - Fold in thirds with pocket visible and then fold in thirds down toward pocket. Turn pocket inside out and stuff bag into pocket.